

DOCUMENTATION TECHNIQUE

MODELE DE SERRE FAMILY22

- DIMENSIONS
- PLAN DE TERRASSEMENT
- PLAN DE REPARTITION DES MASSES

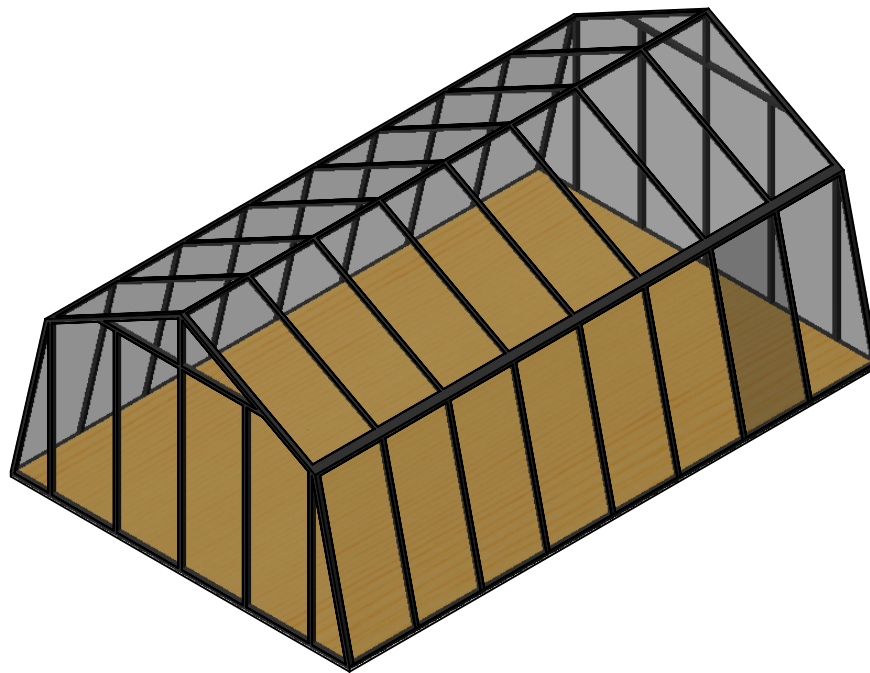

IND	DATE	MODIFICATIONS
A	12/08/2021	Dimensions F22
B	25/08/2021	Cotation des plans de terrassements

DIMENSIONS - FAMILY22

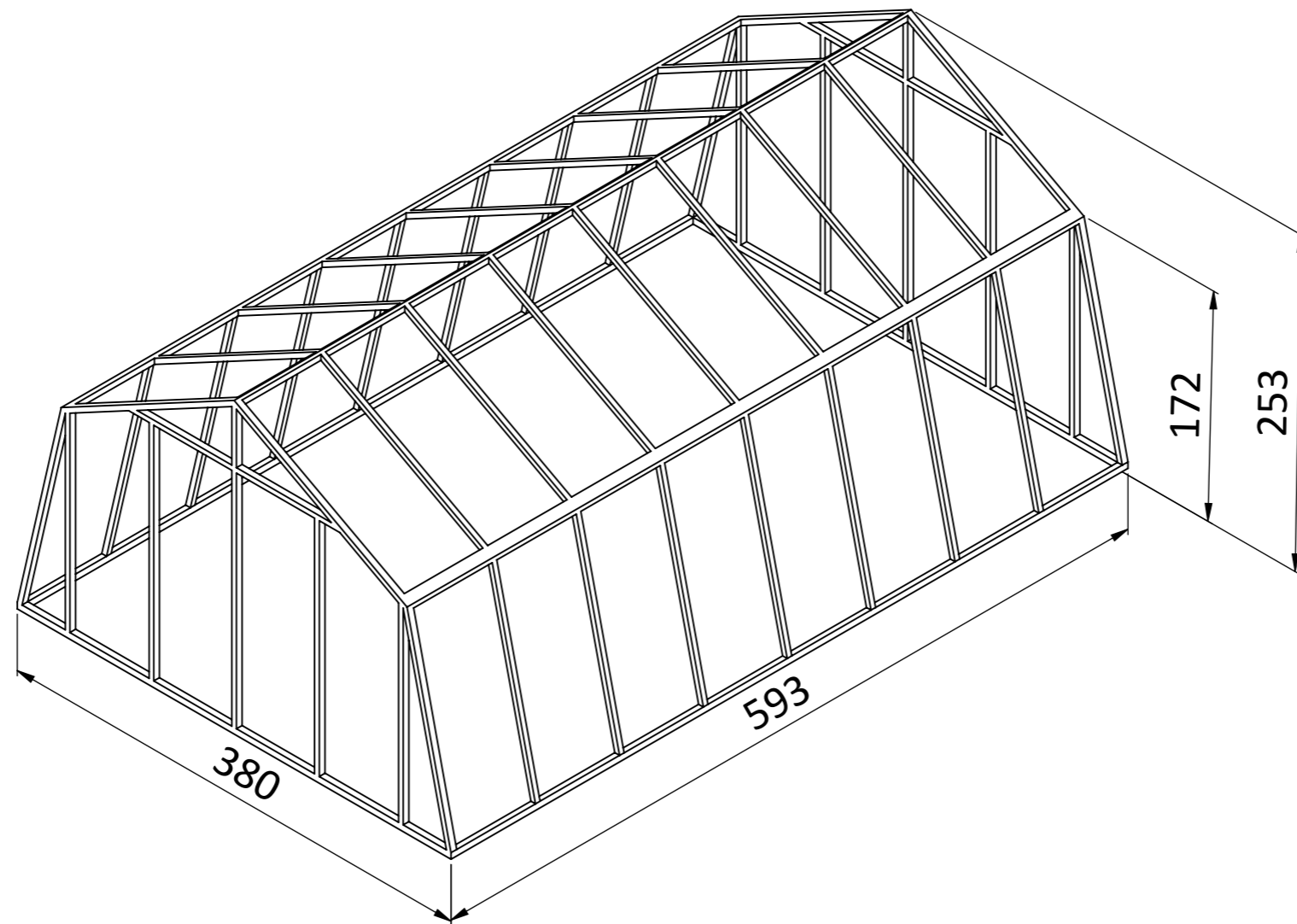
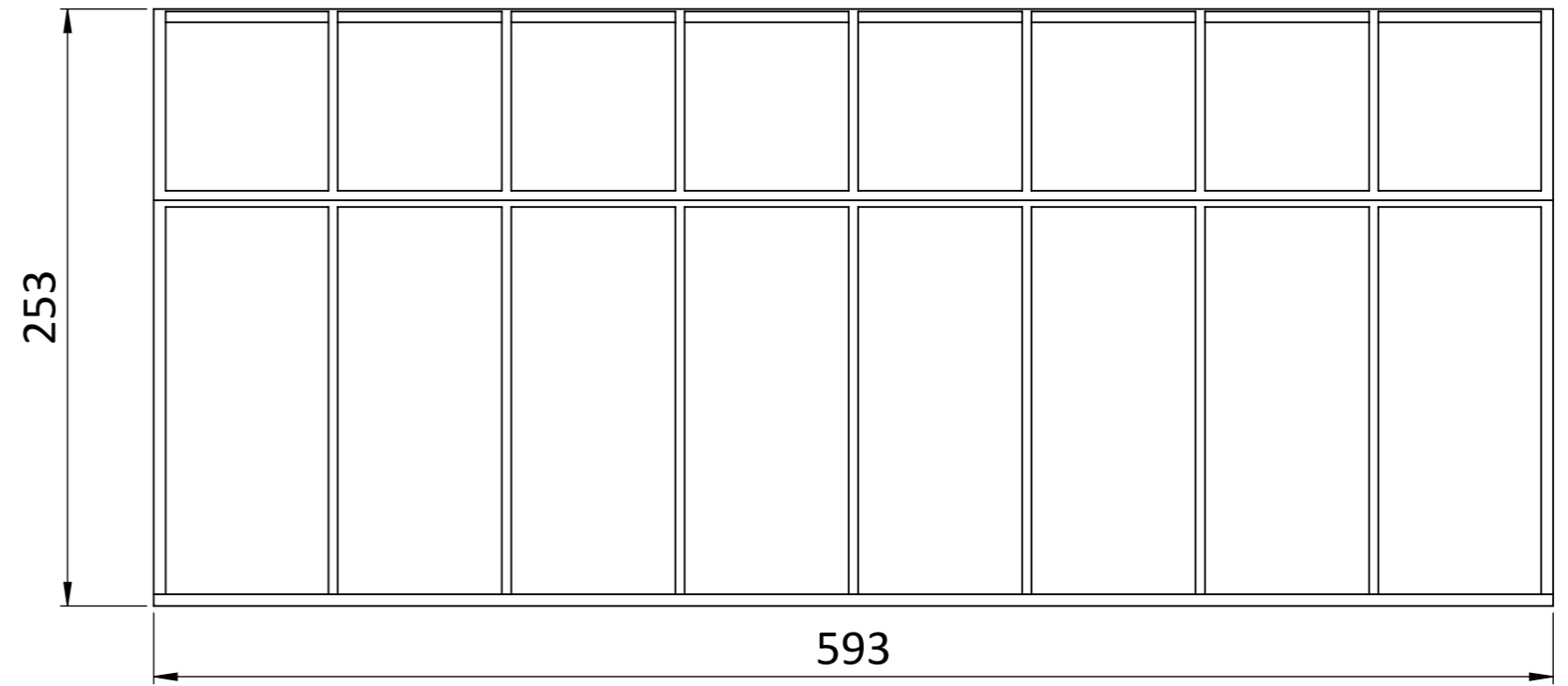
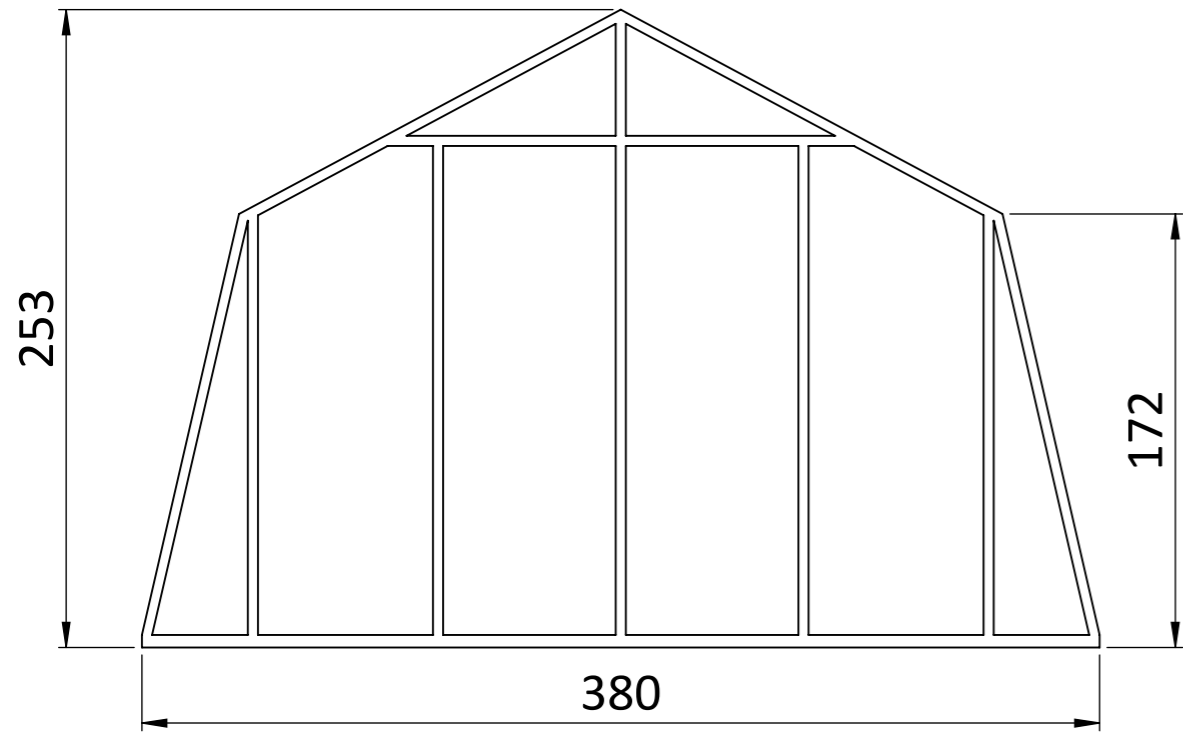

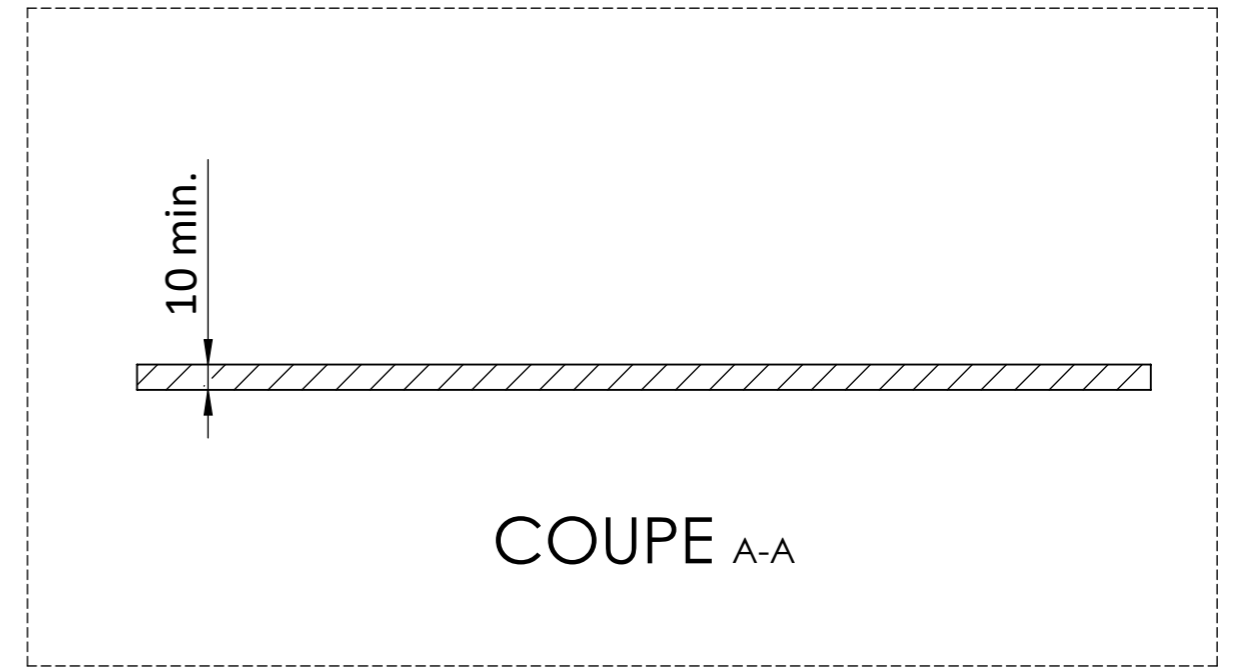
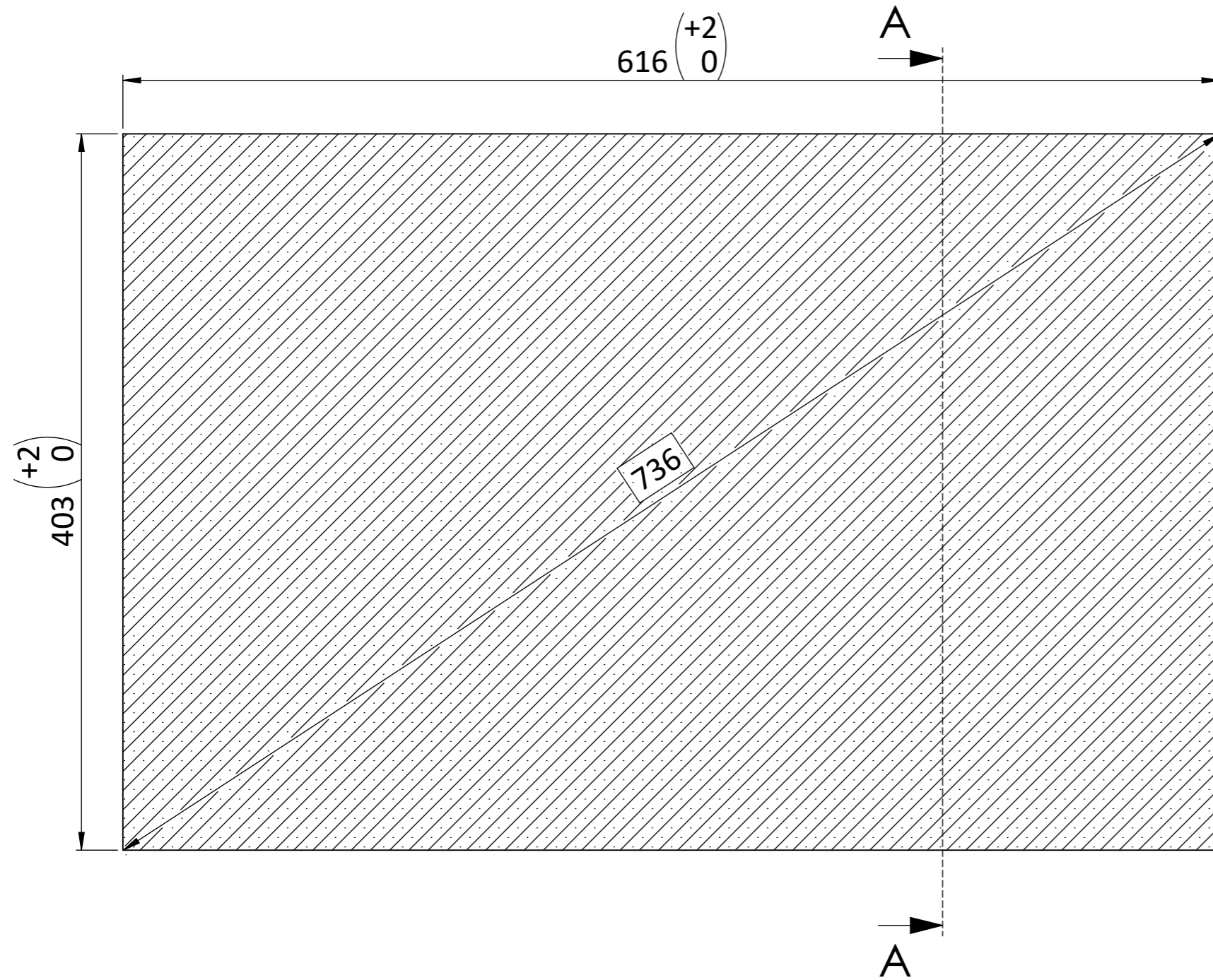

NOTES

Nivellement à plat avec légère pente vers l'arrière pour l'écoulement de l'eau, soit 2 centimètres de surélévation entre l'avant et l'arrière

Planéité : 0.4cm max

POSITIONNEMENT DE L'EMBASE - FAMILY22

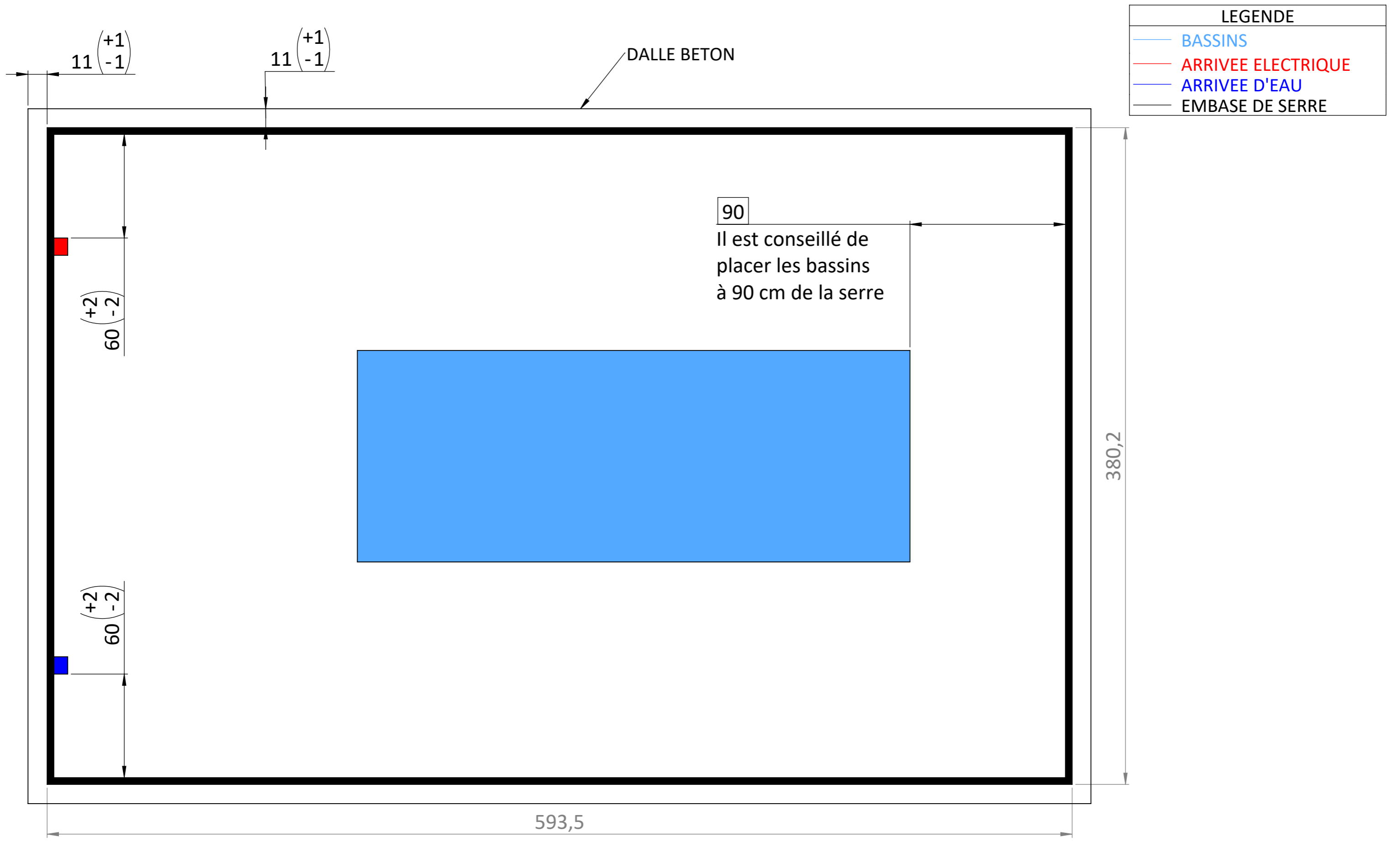

LEGENDE	
—	BASSINS
—	ARRIVEE ELECTRIQUE
—	ARRIVEE D'EAU
—	EMBASE DE SERRE

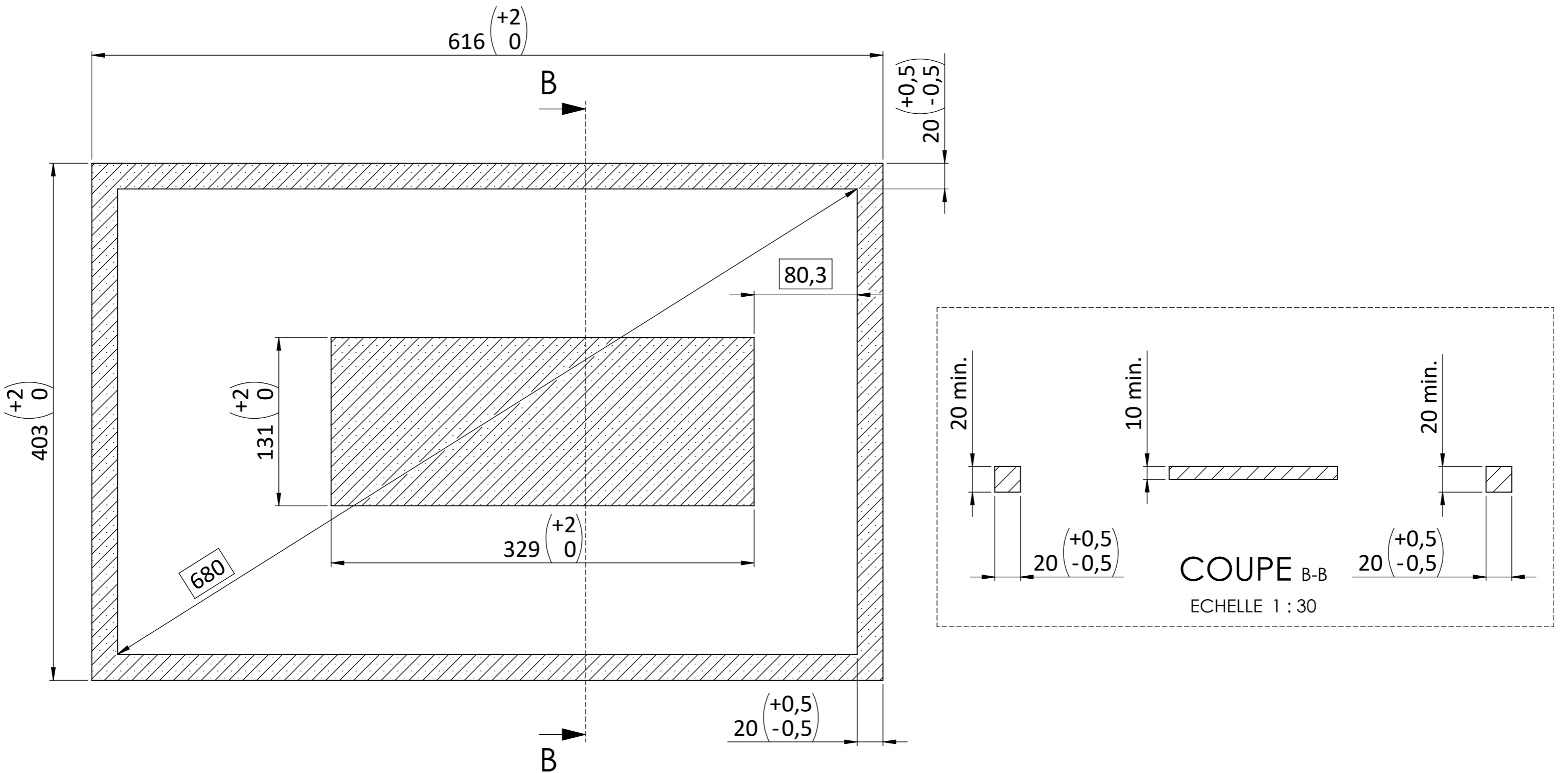

NOTES

Nivellement à plat avec légère pente vers l'arrière pour l'écoulement de l'eau, soit 2 centimètres de surélévation entre l'avant et l'arrière

Planéité : 0.4cm max

POSITIONNEMENT DE L'EMBASE - FAMILY22

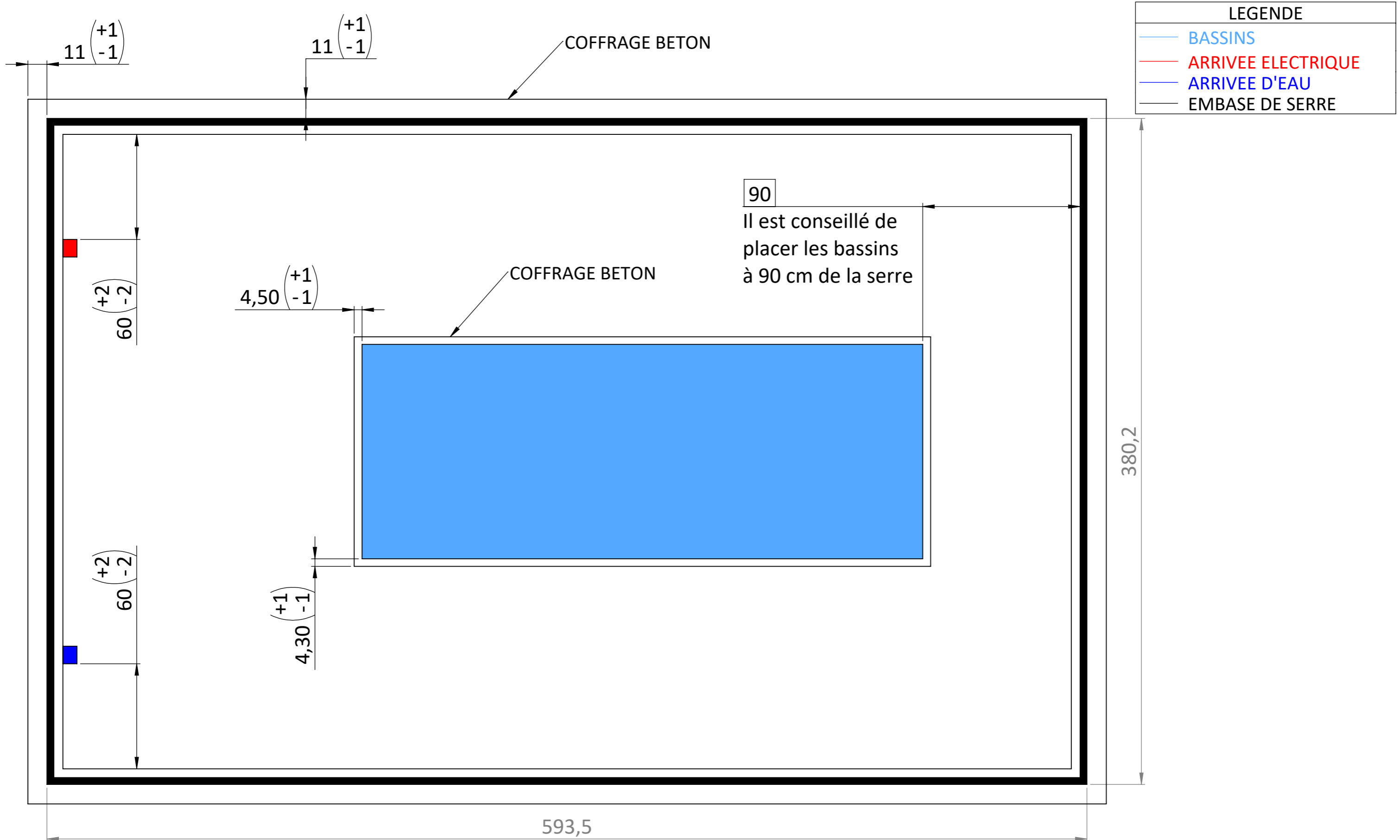

LEGENDE	
	BASSINS
	ARRIVEE ELECTRIQUE
	ARRIVEE D'EAU
	EMBASE DE SERRE

OPTION 1

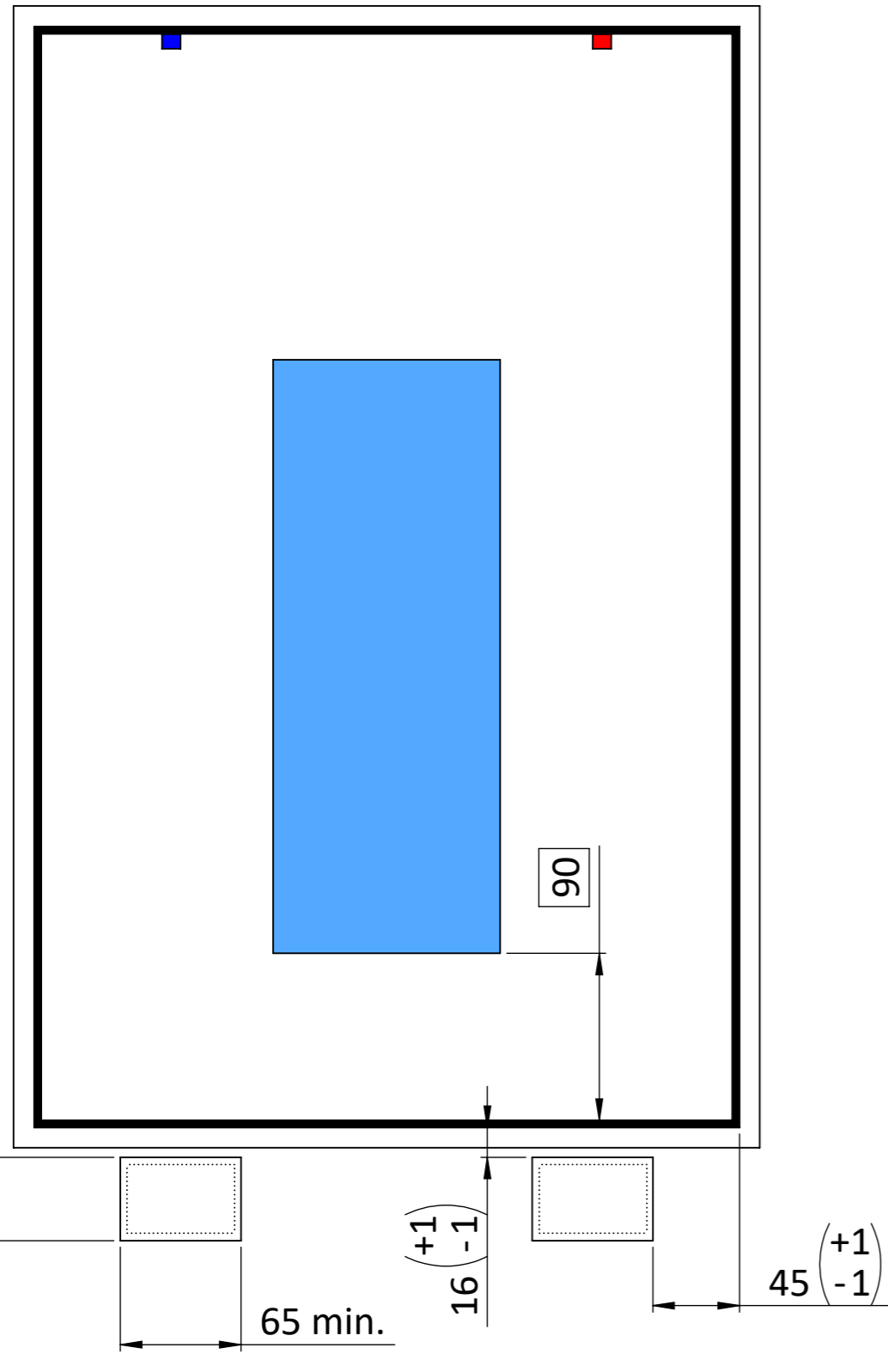

OPTION 2

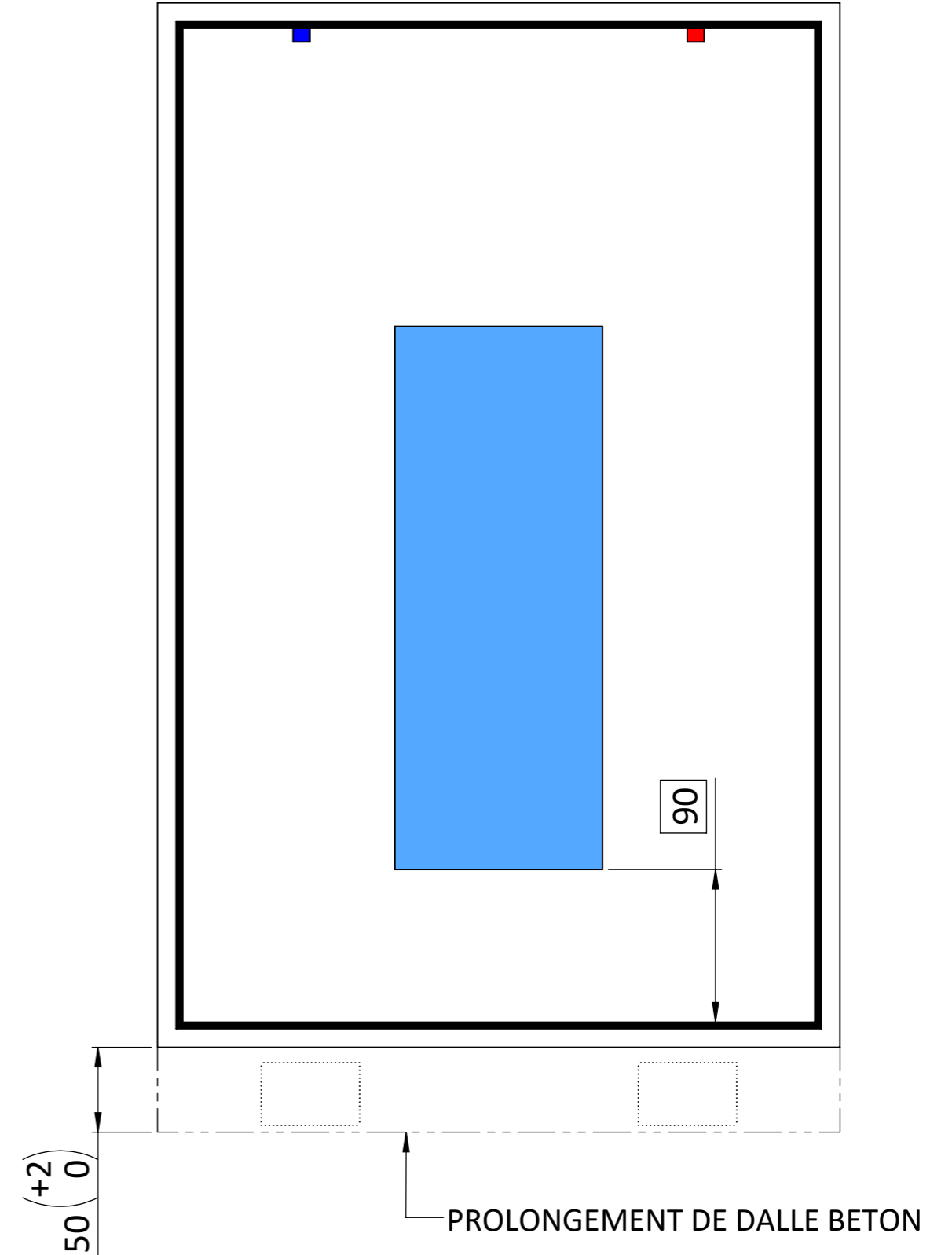

LEGENDE	
—	ARRIVEE ELECTRIQUE
—	ARRIVEE D'EAU
—	EMBASE DE SERRE
.....	RECUPERATEURS D'EAU

INFORMATIONS SUR LE MODELE

SURFACE	22 m ²
MASSE DE LA STRUCTURE	650 kg
MASSE TOTALE	2800 kg

NOTE : PLANCHER SOLIDAIRE AVEC L'EMBASE DE LA SERRE

